



# OPERATOR'S MANUAL

SETTING UP INSTRUCTIONS

INTERNATIONAL®

## QA-36A and QA-42A

## SNOW THROWERS

OPERATION  
MAINTENANCE  
LUBRICATION

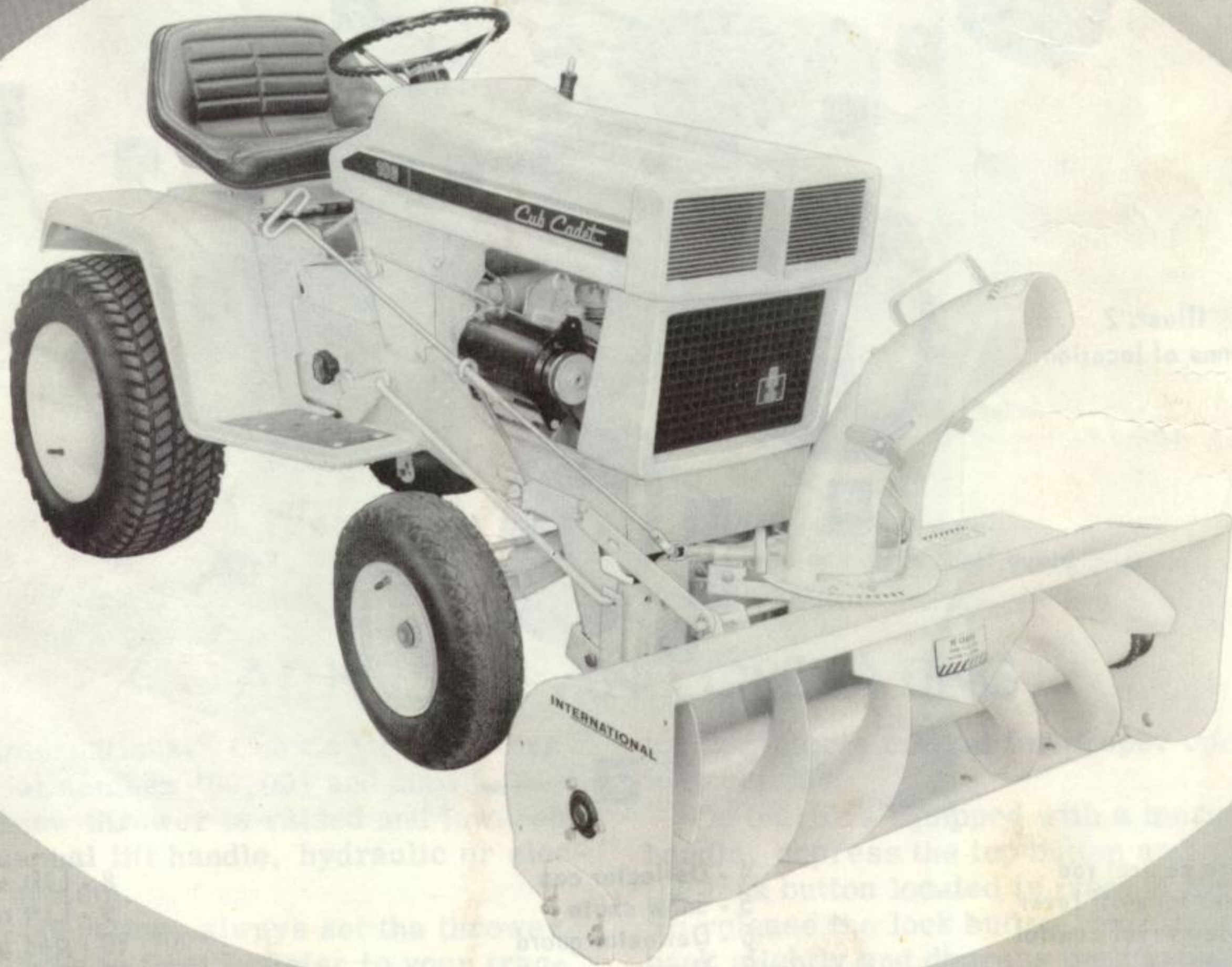



## To The Owner

Your new International Harvester snow thrower is designed to meet today's exacting operating requirements. The ease of operation, and ability to adjust to various conditions lighten your work and shorten your hours on the job.

You are urged to consult your International Harvester dealer concerning unusual conditions or special applications. Let the experience of your dealer and the organization associated with him serve you.

Be sure to read the instructions for Adjusting and Operating in this manual. Check each item referred to and acquaint yourself with the adjustments required to obtain effi-

cient operation and maximum trouble-free service. Remember, a machine which is properly lubricated and adjusted saves time, labor and fuel.

After the operating season, thoroughly clean your snow thrower and inspect it. Preventive maintenance pays dividends. Your dealer has original-equipment parts which assure proper fit and best performance. He is able to recondition your equipment to a like new condition.

Additional copies of this manual may be ordered from your International Harvester dealer at a nominal price.

## INTRODUCTION

The instructions contained in this manual may be used for the QA-36A Snow Thrower also.

Illust. 2  
Terms of location.

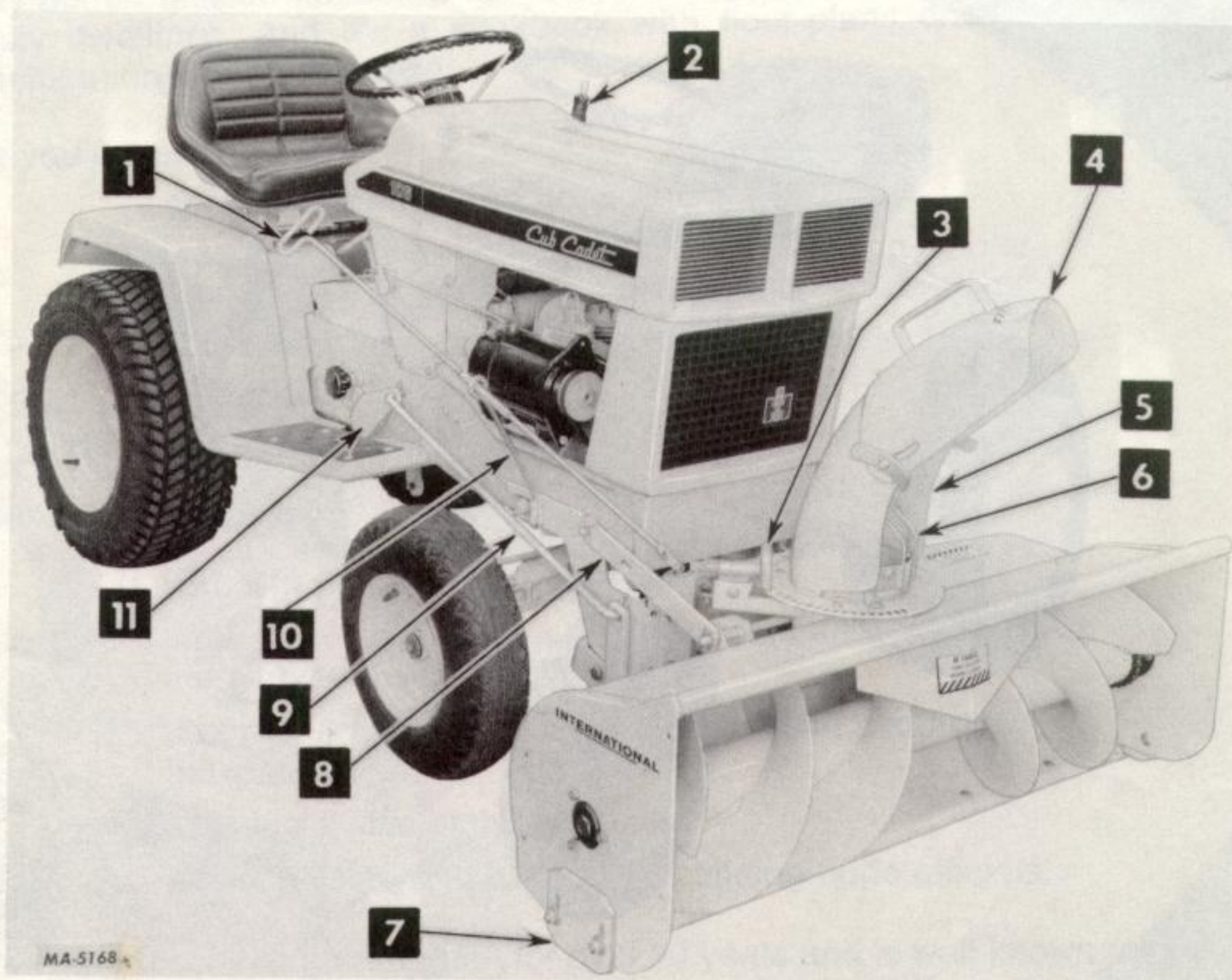

- 1 - Chute control rod
- 2 - Power take-off lever
- 3 - Chute swivel control assembly

- 4 - Deflector cap
- 5 - Snow chute
- 6 - Deflector guard
- 7 - Runner

- 8 - Lift strap
- 9 - Lift rod
- 10 - Rod guard
- 11 - Lift arm



The International QA-36A and QA-42A Snow Throwers are designed for front mounting on International® Cub Cadet® Tractors with Serial Number 400,001 and above.

The thrower has snow clearing widths of 36 inches - QA-36A, or 42 inches - QA-42A and is used for clearing snow from driveways, sidewalks, parking lots, etc.

Each thrower is equipped with two adjustable runners to hold the cutting blade just

above the surface level. These runners are reversible.

The cutting blade is bolted to the front edge of the housing and is reversible and replaceable.

Tractors with Serial Number 400,000 and below require an adapter package to operate the snow thrower, but is not included with it. This package is available at your International Harvester dealer.

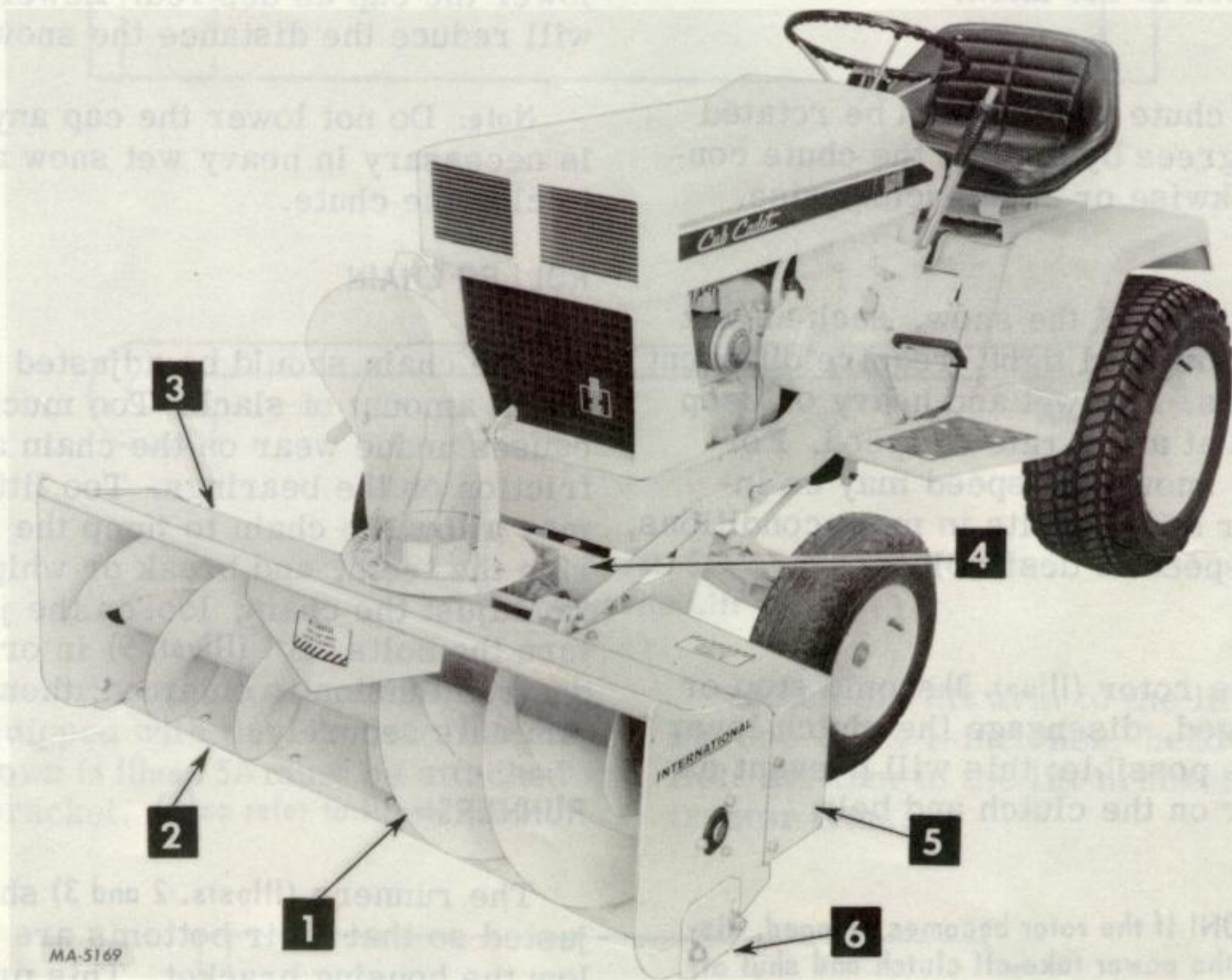

Illust. 3

- |                     |                                 |
|---------------------|---------------------------------|
| 1 - Rotor           | 4 - Front mounting plate        |
| 2 - Blade           | 5 - Chain and drive shaft guard |
| 3 - Thrower housing | 6 - Runner                      |

## ADJUSTING AND OPERATING

For International® Cub Cadet® Tractors with serial number 400,001 and above.

The snow thrower is raised and lowered by the manual lift handle, hydraulic or electric lift system.

When operating, always set the thrower so it is "free to float". Refer to your trac-

tor operator's manual for proper operating instructions.

On tractors equipped with a manual lift handle, depress the top button and press in the lock button located in front of the handle. To release the lock button, pull the handle back slightly and depress the top button.



## ADJUSTING AND OPERATING

### GENERAL

On tractors with serial number 400,000 and below having hydraulic lift unit, raise the end clevis locking clip up, into the unlocked position. See *Illust. 11*.

The power take-off clutch lever (*Illust. 2*) is used to start and stop the snow thrower. To start the thrower, push the clutch lever to the forward notch in the lever latch. To stop the thrower, pull the clutch lever to the rearward notch in the latch.

The snow chute (*Illust. 2*) can be rotated a full 180 degrees by turning the chute control rod clockwise or counterclockwise.

The conditions of the snow, such as wet and heavy or dry and light, require different tractor speeds. For wet and heavy or deep snow, travel at a low rate of speed. For light and dry snow, the speed may be increased. For best results in most conditions, high engine speed is desirable.

**Note:** If the rotor (*Illust. 3*) should stop or become plugged, disengage the clutch lever as quickly as possible; this will prevent excessive wear on the clutch and belt.



**CAUTION!** If the rotor becomes plugged, disengage the power take-off clutch and shut off the tractor engine before attempting to unplug it.



**CAUTION!** Be careful when operating the snow thrower at high speeds; the driver could be unseated by a collision with a hidden object.

### V-BELT

The belt should be adjusted to have enough tension to keep it from slipping. Turn belt tension screw counterclockwise until all slack is out of the belt. Then, tighten an additional 3 to 3-1/2 turns for proper tension. See *Illust. 8*.

### DEFLECTOR CAP

To adjust the cap (*Illust. 2*), loosen the wing nuts on each side of the chute and raise or lower the cap as desired. Lowering the cap will reduce the distance the snow is thrown.

**Note:** Do not lower the cap any more than is necessary in heavy wet snow as this tends to clog the chute.

### ROLLER CHAIN

The chain should be adjusted to have a slight amount of slack. Too much tension causes undue wear on the chain and wasteful friction on the bearings. Too little tension may allow the chain to jump the sprockets, ride the teeth, and break or whip excessively. To adjust the chain, loosen the jam nut and turn the bolts "B" (*Illust. 9*) in or out until the desired tension is obtained; then tighten the jam nuts securely.

### RUNNERS

The runners (*Illusts. 2 and 3*) should be adjusted so that their bottoms are slightly below the housing bracket. This prevents the cutting blade from riding on the ground and allows it to clear cracks in sidewalks and driveways, etc. Proper adjustment of the runners will eliminate excessive wear on the blade.

## SETTING UP

Remove all parts from the shipping carton and arrange the parts conveniently.

Bolts must be used in the holes in which they are found, or in the parts to which they are attached, unless otherwise shown.

Lubricate all moving parts as you proceed, and see that they work freely.

Whenever the terms "left" and "right" are used, it should be understood to mean from a position behind and facing the machine.



If the tractor serial number 400,000 and below is equipped with Hydraulic Lift Unit attachment, the lift arm shown in *Illust. 5* must be attached to the lift bracket. (Also refer to *Illust. 11*).

Attach the lift arm using one spacer  $1/2$  x  $1-1/32$ -inch pipe, one  $1/2$  x  $1-7/8$ -inch hex. head cap screw, and one  $1/2$ -inch medium lock washer.

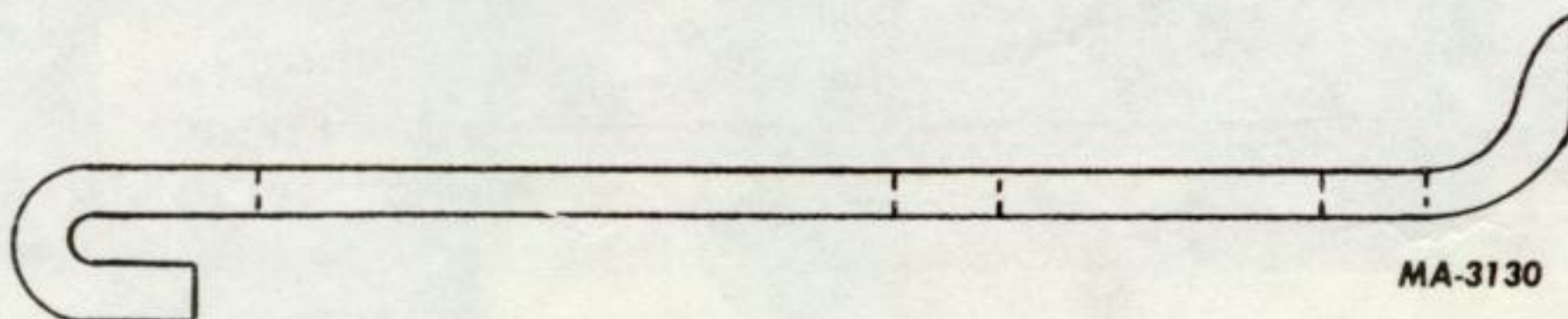
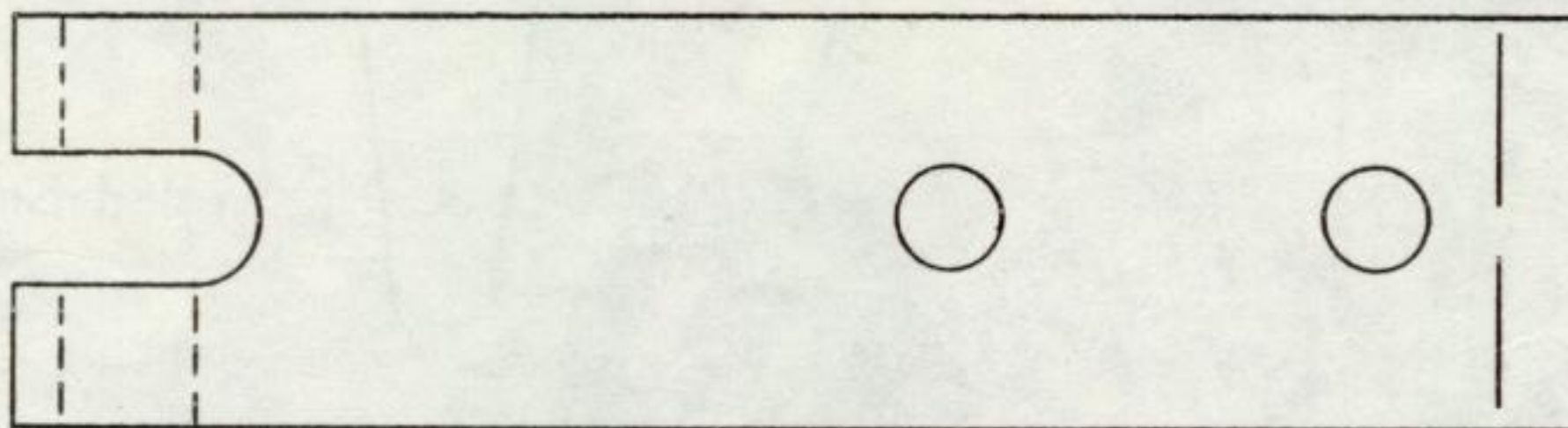

*Illust. 5*  
For Hydraulic Lift Unit.

If the tractor serial number 400,000 and below is equipped with the Electric Lift, the lift arm shown in *Illust. 5A* must be attached to the lift bracket. (Also refer to *Illust. 12*).

Attach the lift arm to the lift bracket using one  $1/2$  x 1-inch hex. head cap screw, Bolt lift arm to the lift bracket outside the tractor frame.

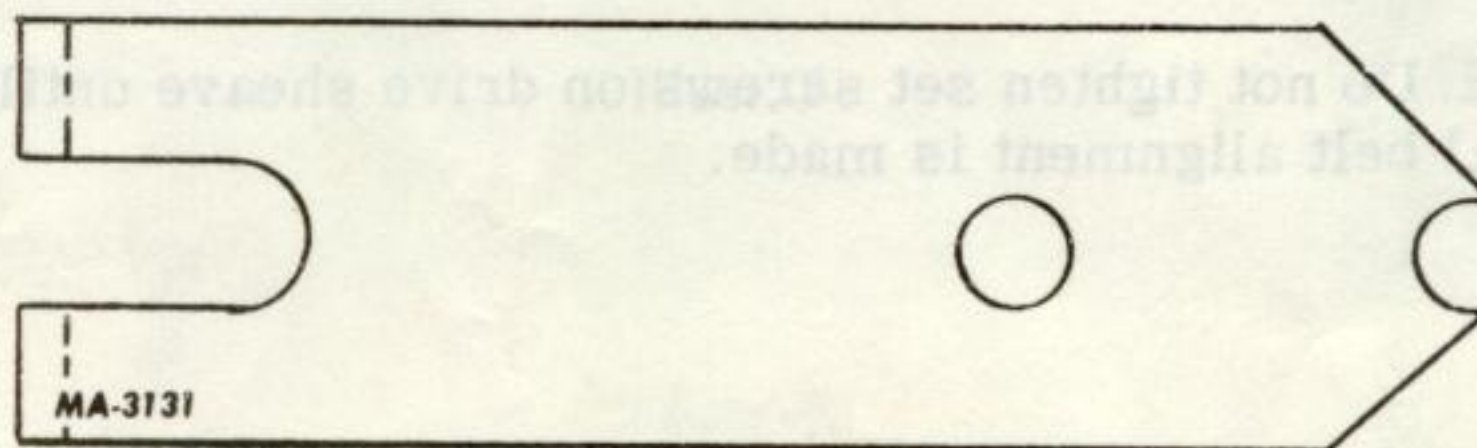

*Illust. 5A*  
For Electric Lift.



## SETTING UP AND OPERATING

### STEP 1. DRIVE SHEAVE

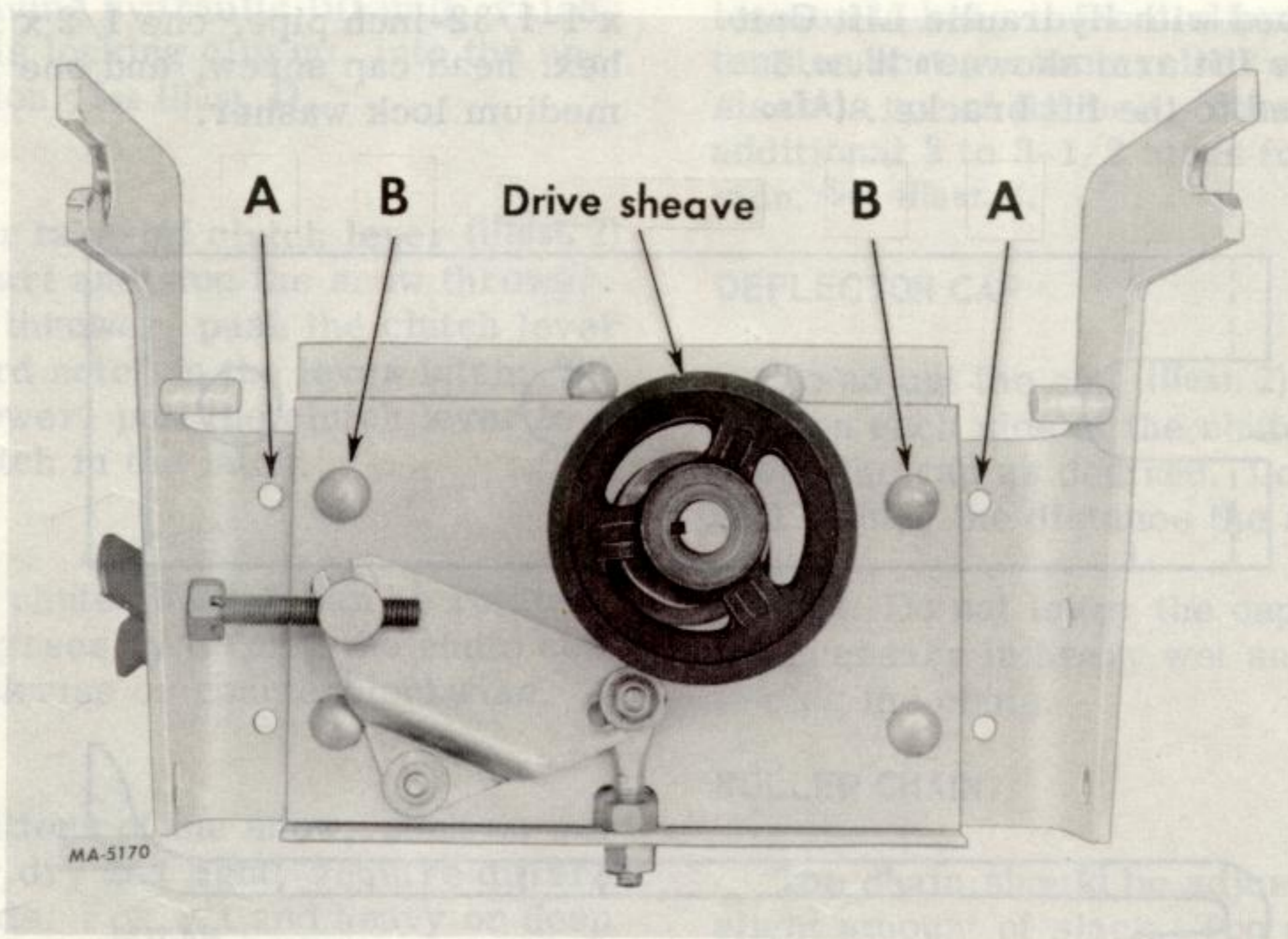

Illust. 6

Place bolts in hole "A" for tractors with serial number 400,000 and below.

Place bolts in hole "B" for tractors with serial number 400,001 and above.

**NOTE:** Do not tighten set screws on drive sheave until final belt alignment is made.



STEP 2. FRONT MOUNTING ASSEMBLY AND LIFT BRACKET

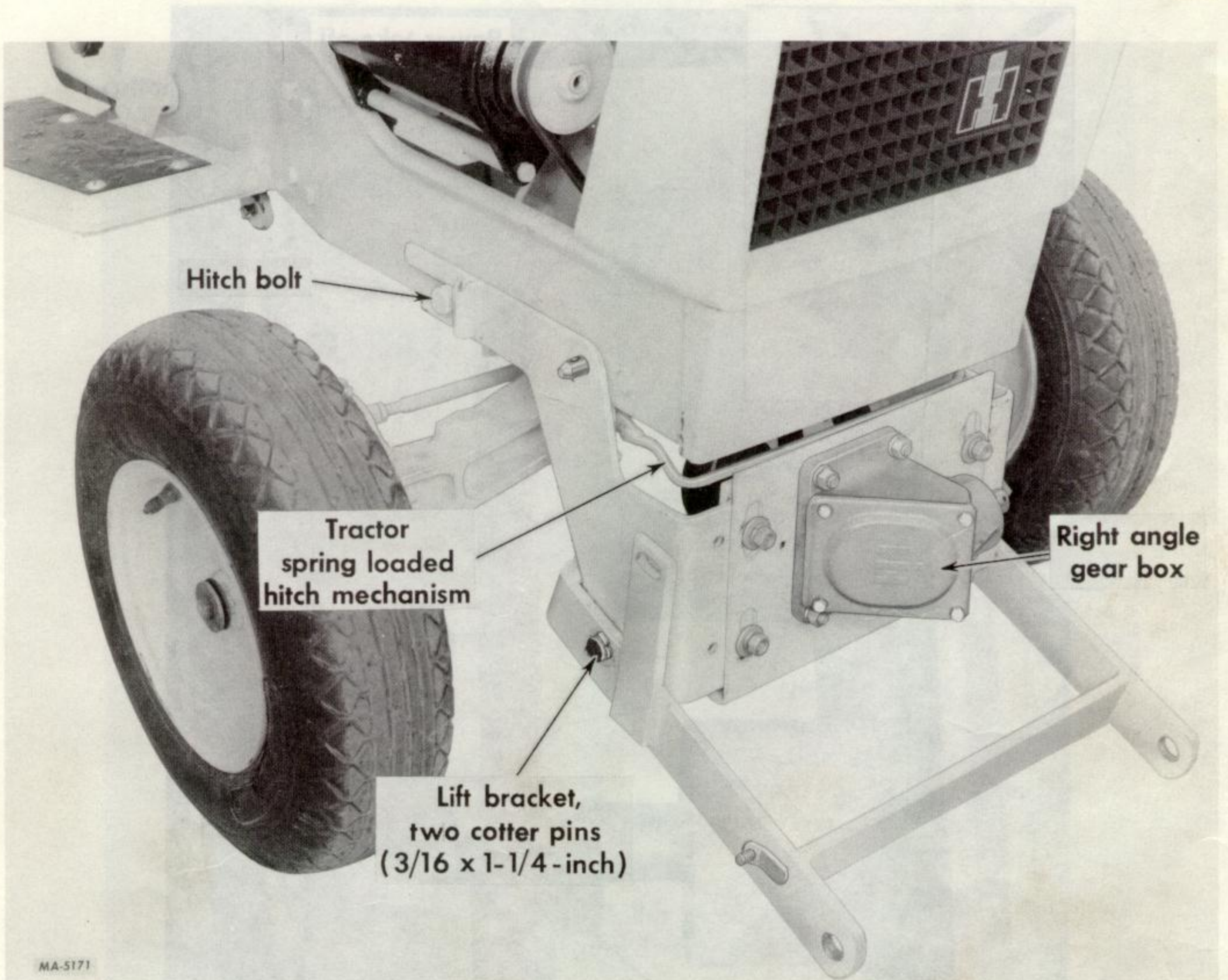

MA-5171

Illust. 7

Note: Be sure drive sleeve is in alignment with the tractor power take-off shaft. The belt tension screw is located on either the lower left side of the front mounting assembly (as shown in Illust. 8) or at the bottom center of the front mounting assembly.

To obtain proper belt tension after belt is in place, turn belt tension screws counter-clockwise until slack is out of the belt. (Belt sides will be straight.) Then tighten an additional 3-3 1/2 turns.

Note: If belt tension screw is located at the bottom center of the front mounting assembly the sure belt tension screw handle is in the locked position (parallel with the front mounting plate) after adjustment.



## SETTING UP

### STEP 3. DRIVE BELT

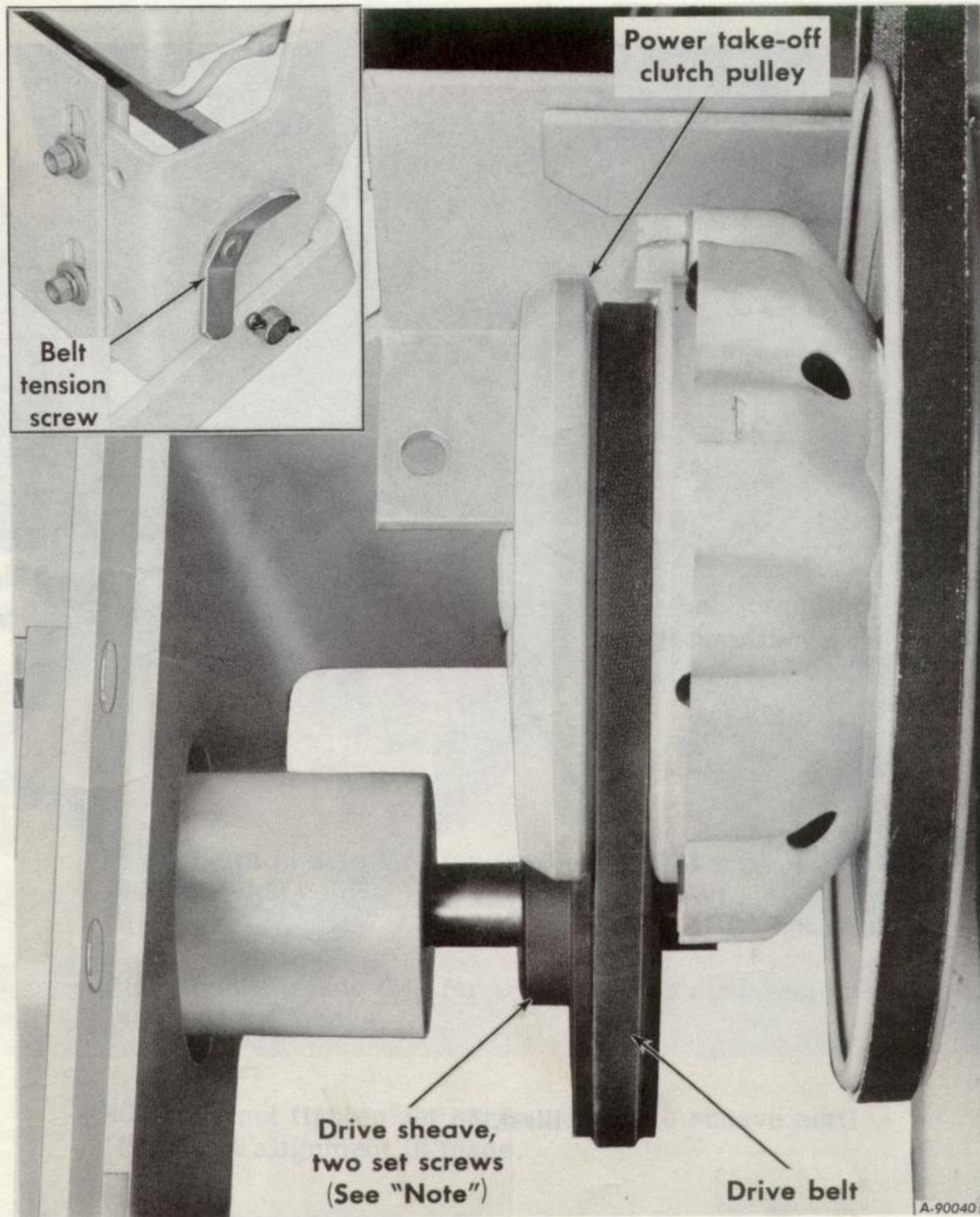

Illust. 8

**Note:** Be sure drive sheave is in alignment with the tractor power take-off clutch pulley.

The belt tension screw is located on either the lower left side of the front mounting assembly (as shown in Illust. 8) or at the bottom center of the front mounting assembly.

To obtain proper belt tension after belt is in place, turn belt tension screws counter-

clockwise until slack is out of the belt. (Belt sides will be straight.) Then, tighten an additional 3-3-1/2 turns.

**Note:** If belt tension screw is located at the bottom center of the front mounting assembly be sure belt tension screw handle is in the locked position (parallel with the front mounting plate) after adjustment.



STEP 4. UNIVERSAL YOKES AND THROWER HOUSING

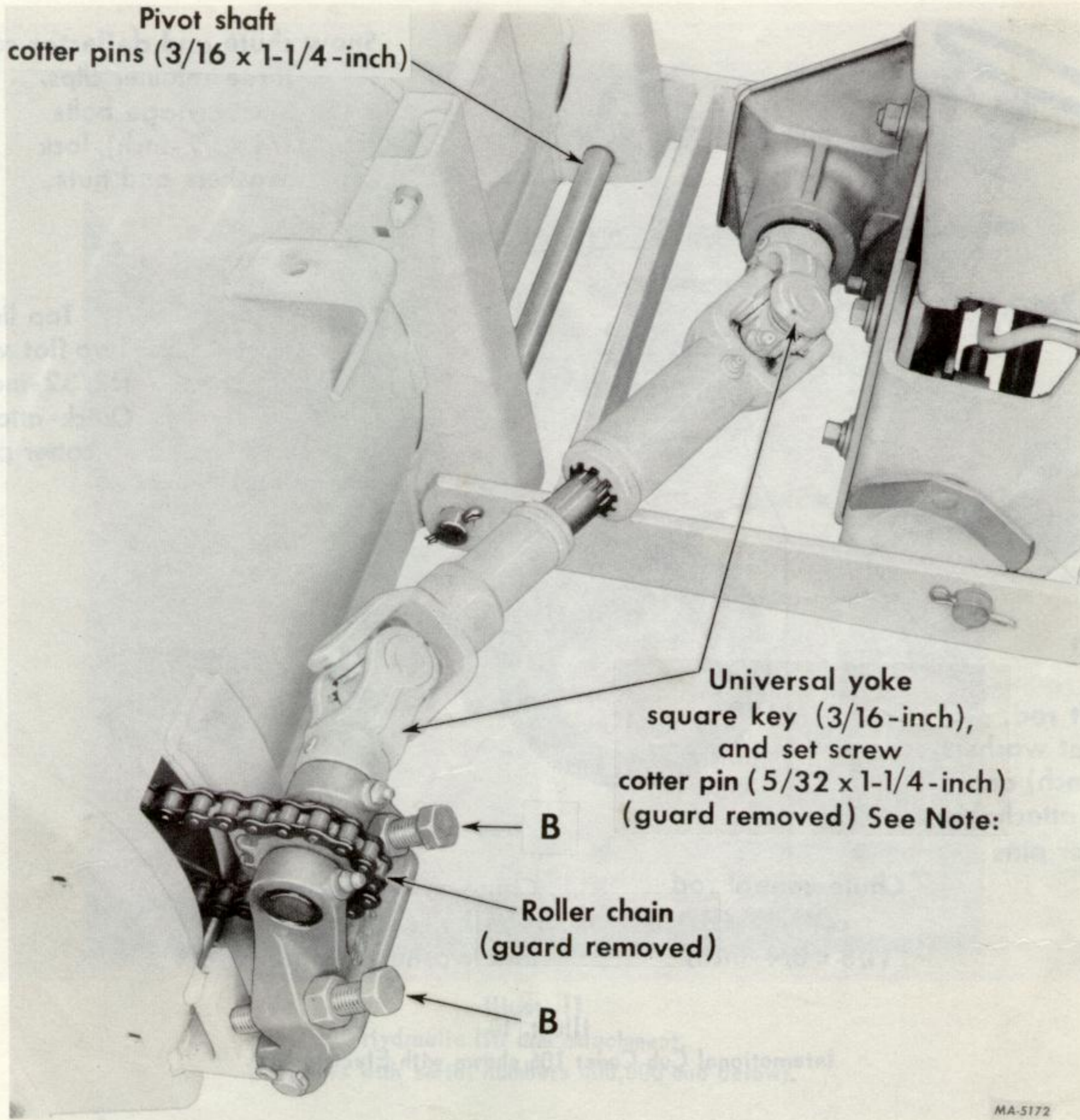

Illust. 9

NOTE: After inserting cotter pin in end of output shaft, spread the pin.



## SETTING UP

### STEP 5. SNOW CHUTE, CHUTE SWIVEL CONTROL, CHUTE CONTROL HANDLE, LIFT ARM, AND LIFT ROD

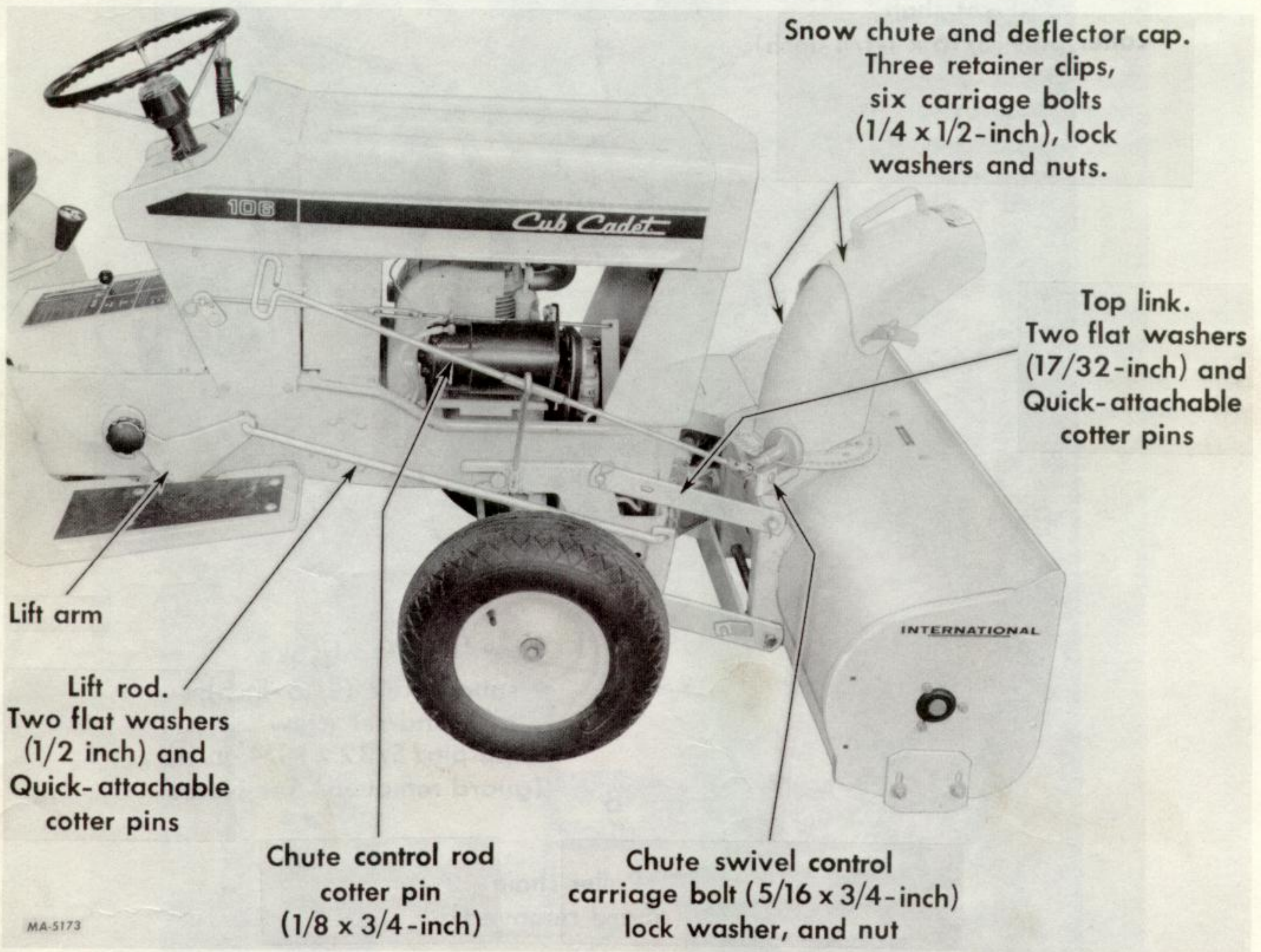

Illust. 10

International Cub Cadet 106 shown with Electric Lift.



STEP 5. SNOW CHUTE, CHUTE SWIVEL CONTROL, CHUTE CONTROL HANDLE, LIFT ARM, AND LIFT ROD — Continued

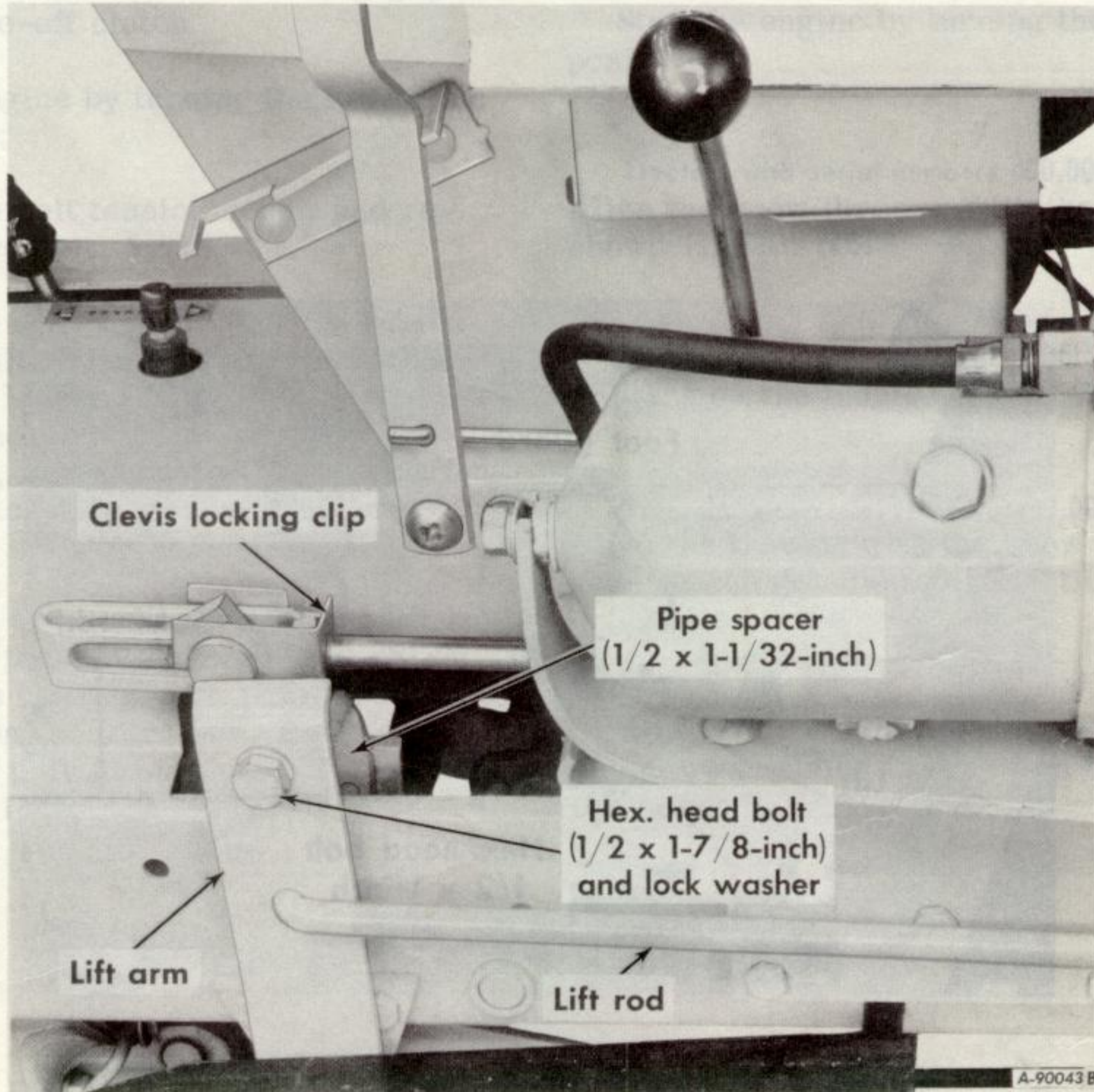

Illust. 11  
Hydraulic lift arm attachment.  
(Tractors with serial numbers 400,000 and below).



## SETTING UP

### STEP 5. SNOW CHUTE, CHUTE SWIVEL CONTROL, CHUTE CONTROL HANDLE, LIFT ARM, AND LIFT ROD —Continued

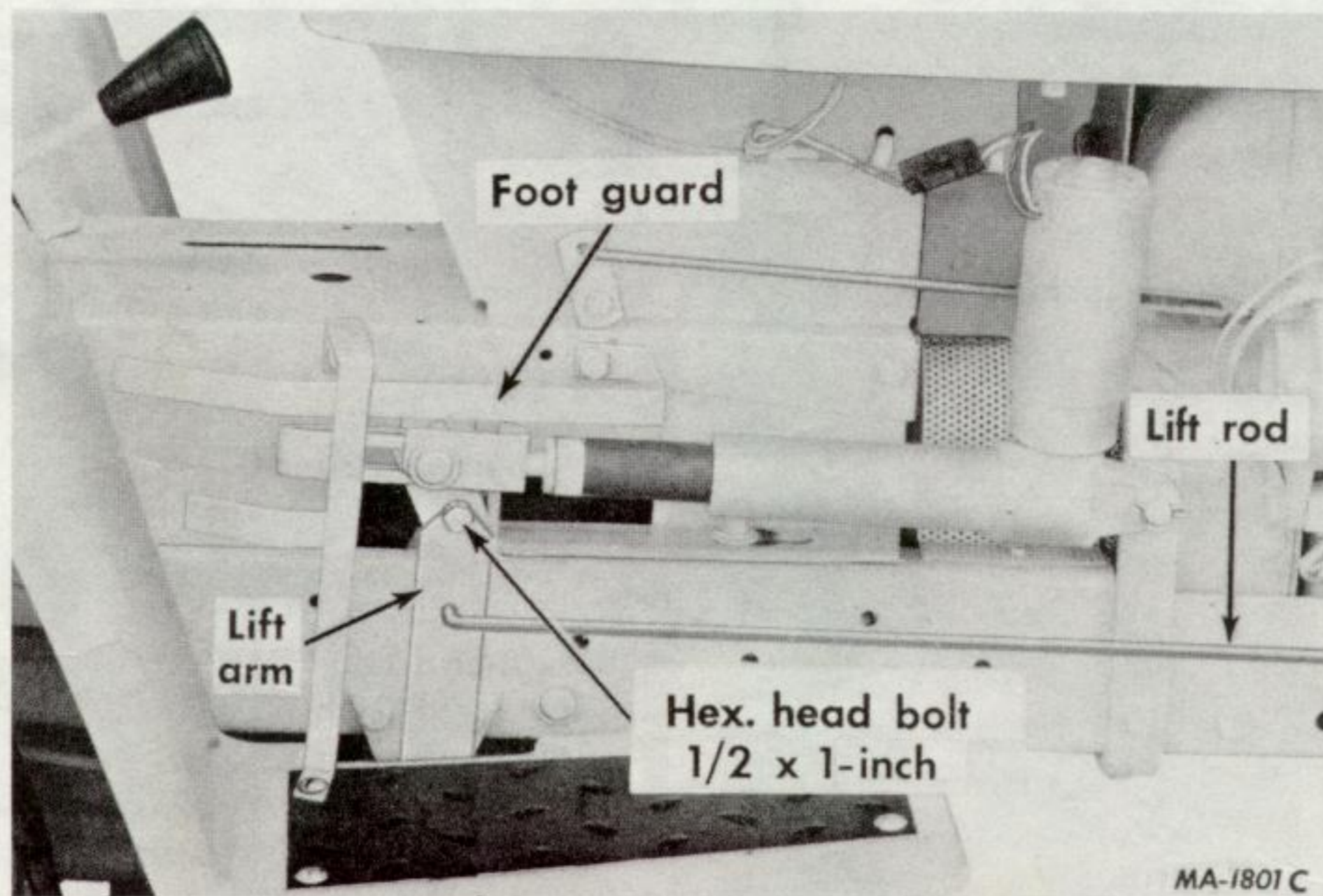

Illust. 12

Electric lift arm attachment.

(Tractors with serial numbers 400,000 and below).



# DETACHING AND ATTACHING

## DETACHING

Drive tractor with snow thrower to storage location.

Lock the tractor brakes and disengage the power take-off clutch.

Stop the engine by turning the key to the "off" position.

Loosen the belt tension screw and remove the drive belt. See Illust. 8.

Tractors with serial numbers 400,001 and above: Remove the lift rod from the lift bracket and lift arm, loosen the hitch bolts, remove the quick-attachable cotter pin from the upper lift strap, and secure with the wing nut on the lift bracket assembly. See Illusts. 13 and 14.

Tractors with serial numbers 400,000 and below: Readjust belt tension screw so that pulley gear box does not interfere with latch "A" when removing from tractor. Press down latch "A" and pull snow thrower from tractor. See Illust. 14A.

## ATTACHING

Drive tractor into position and lock the brakes. Also, disengage the power take-off clutch.

Stop the engine by turning the key to "off" position.

Tractors with serial numbers 400,000 and below: Align the snow thrower with the tractor as shown in Illust. 14B.

Raise the snow thrower until it latches in place on the tractor frame. See Illust. 15A.

Tractors with serial numbers 400,001 and above: Align the tractor with the snow thrower and reverse the detaching instructions shown in Illust. 13.

Attach drive belt and tighten the belt tension screw. Refer to Step 3 in the Setting Up Instructions. See Illust. 8.

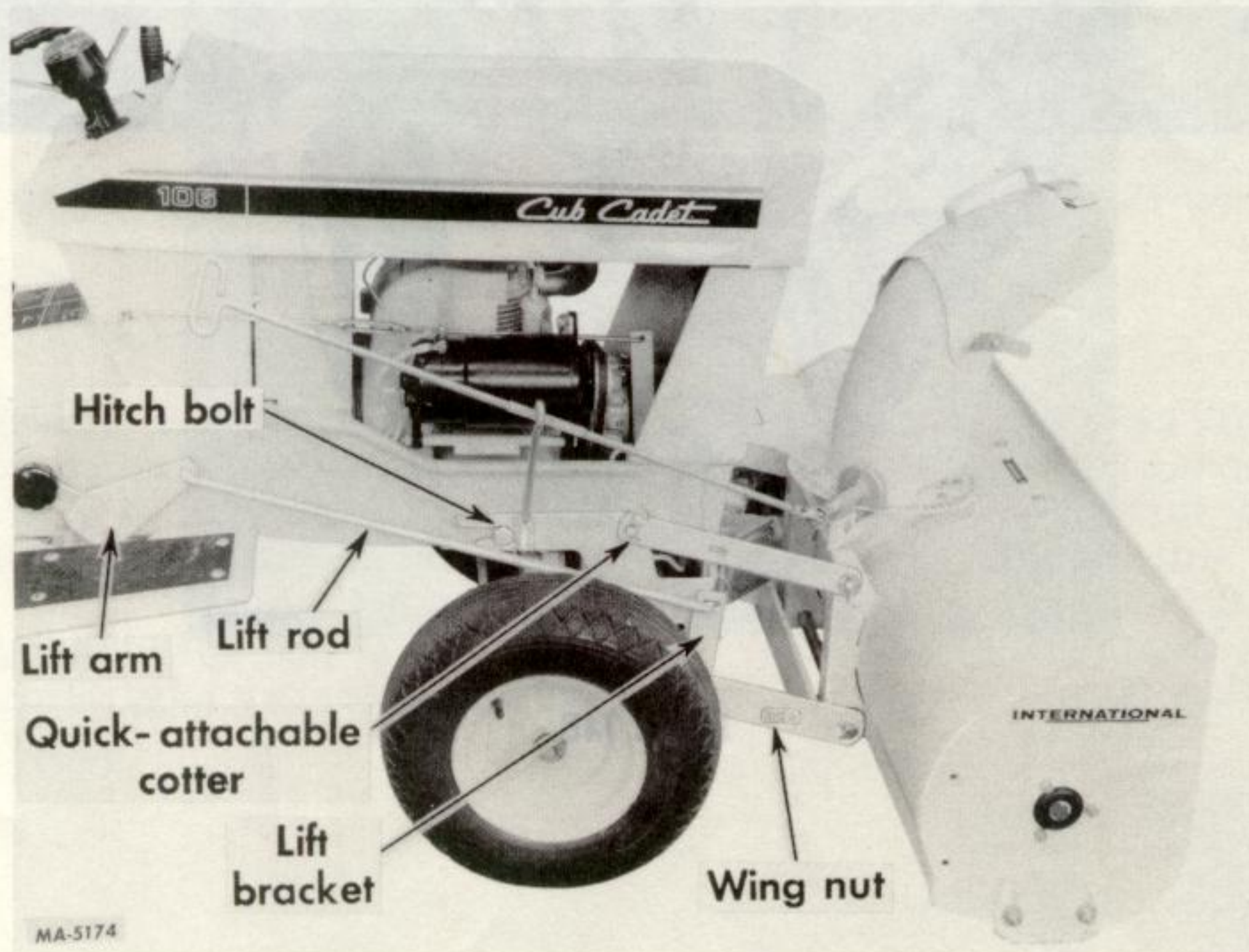

Illust. 13



# DETACHING AND ATTACHING

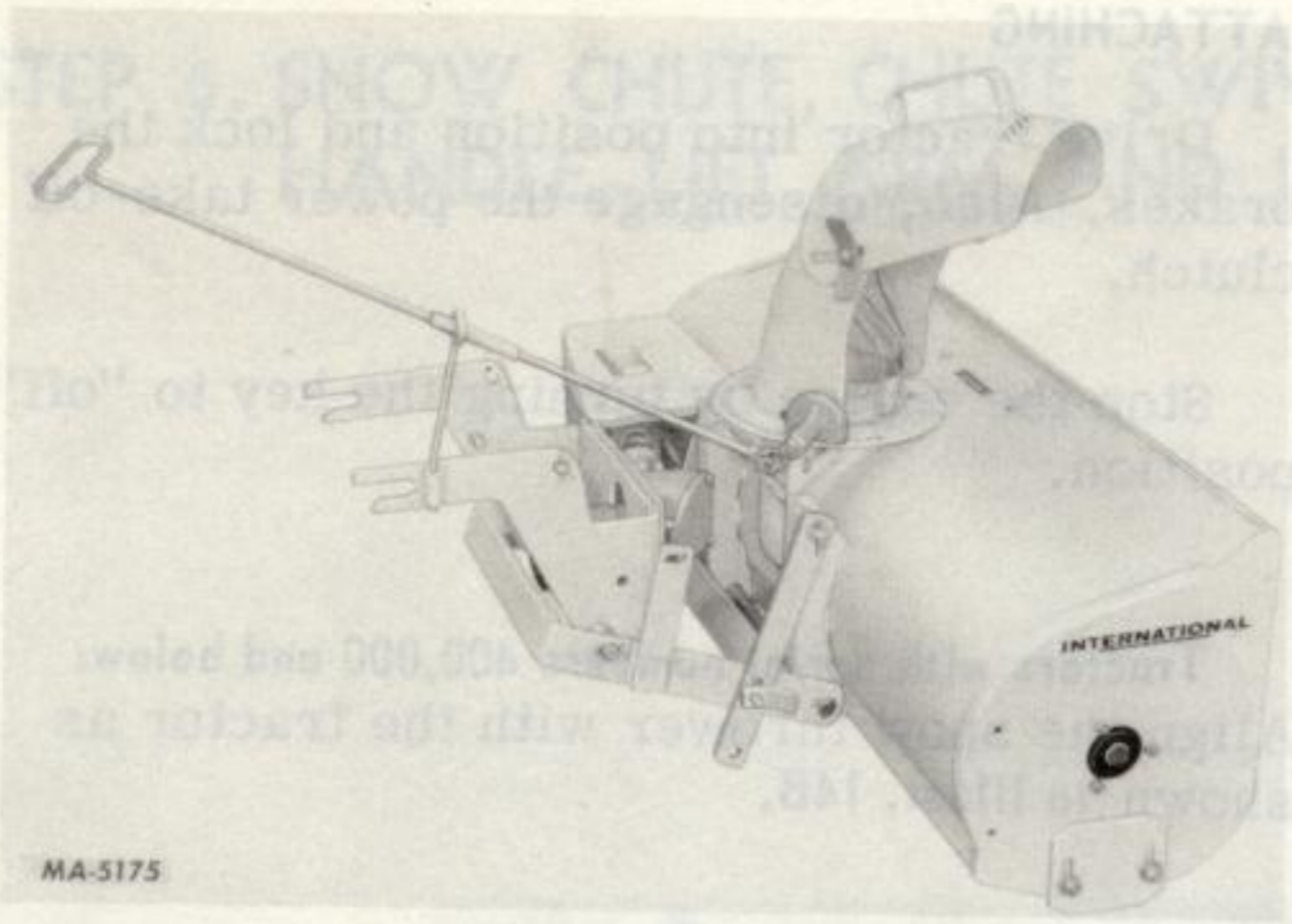

Illust. 14

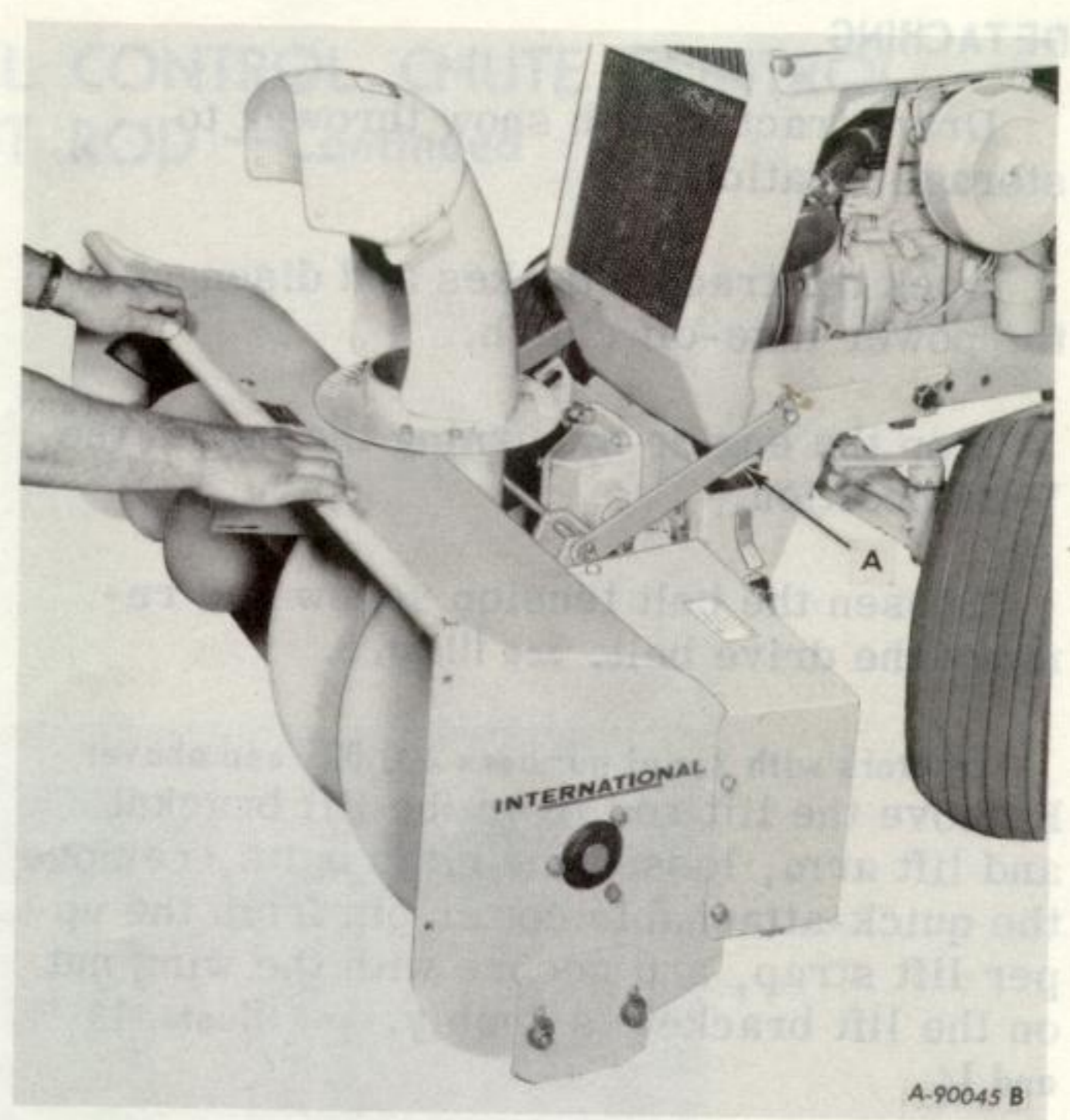

Illust. 14A

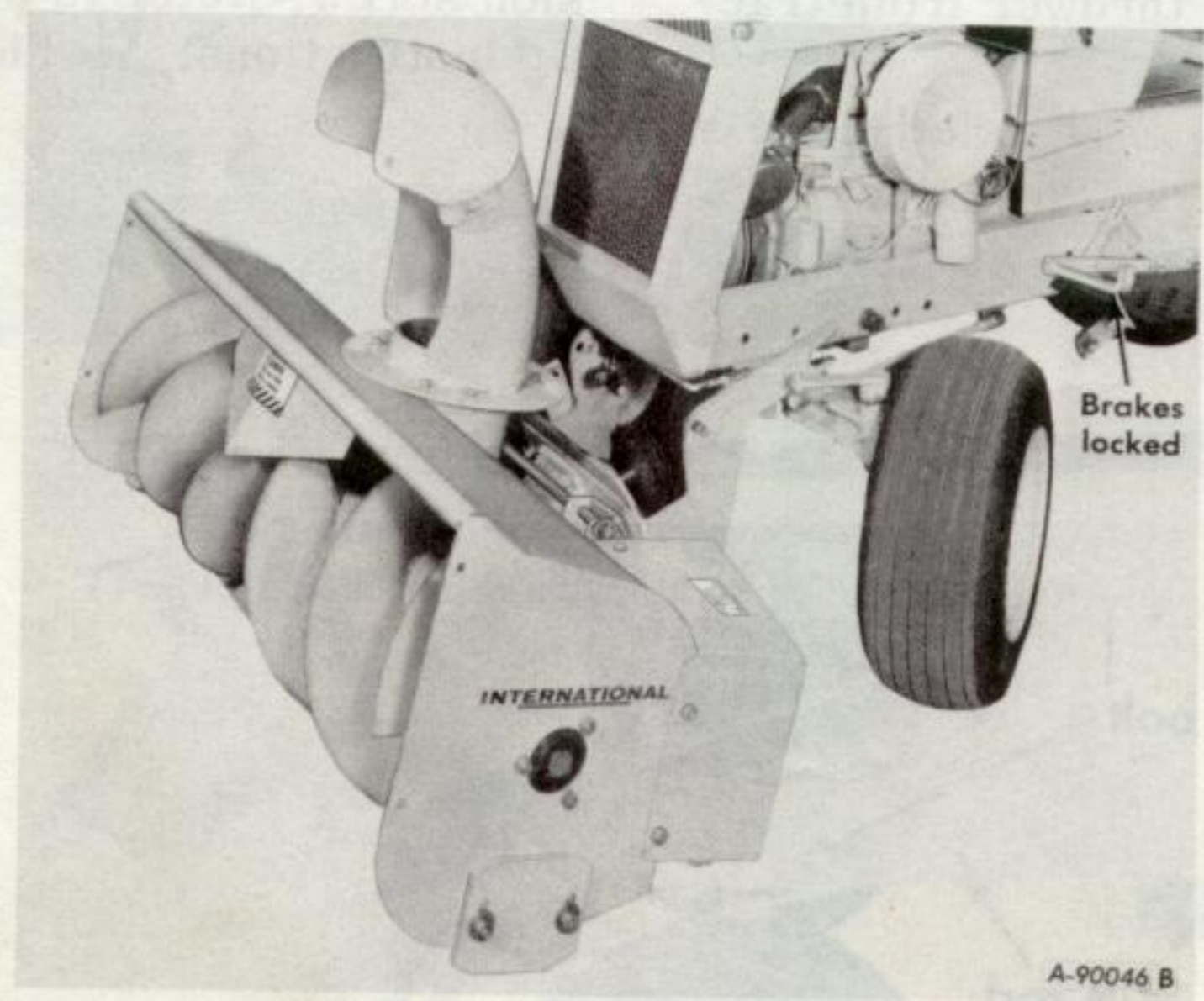

Illust. 14B



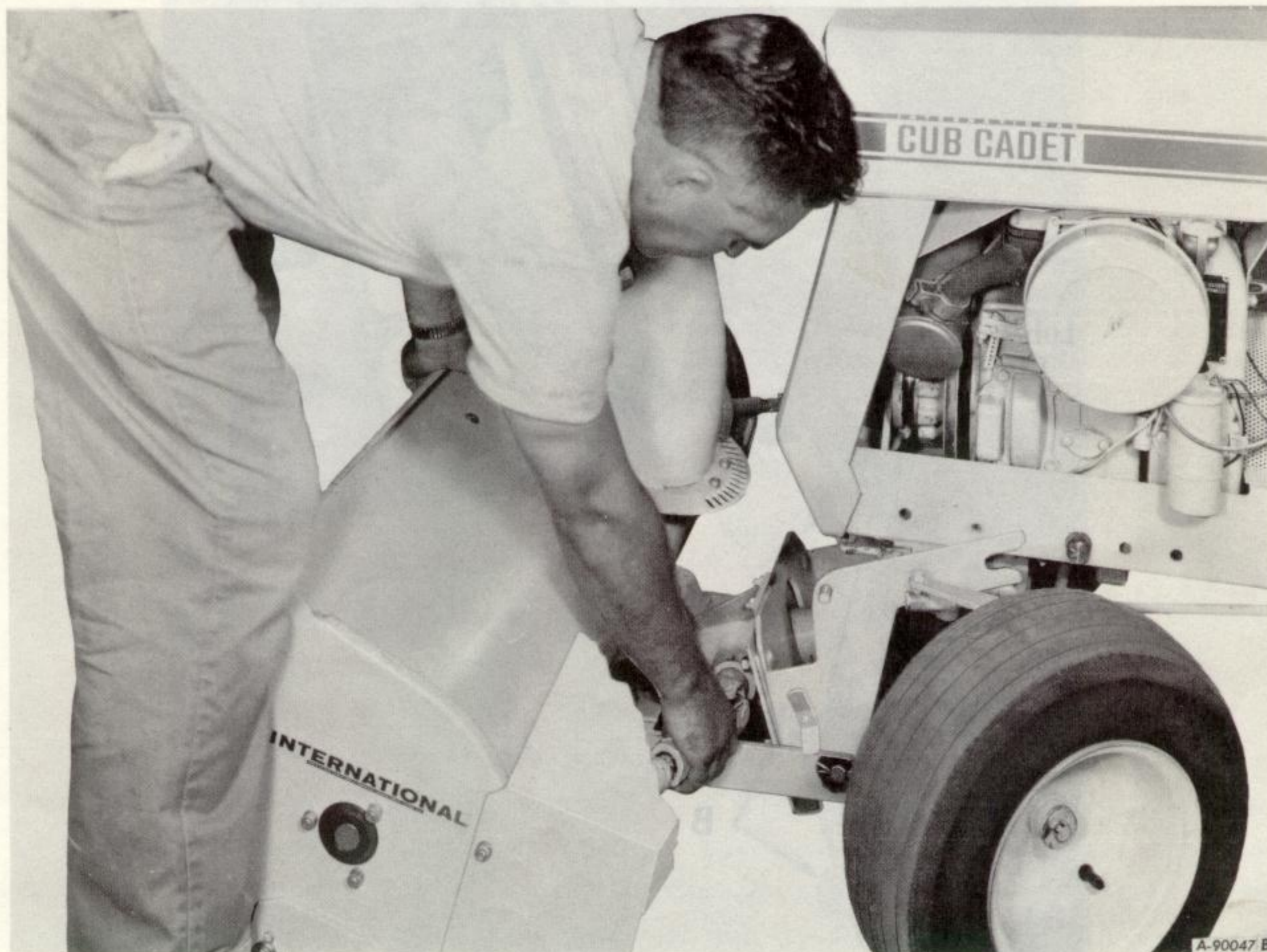

Illust. 15

Each time the snow thrower is used, lubricate the universal drive assembly and the transfer shaft, using IH 251H EP grease or equivalent #2 multi-purpose lithium grease.

The rotor and idler bearings are sealed and do not require lubrication.

The right-angle gear box is either a sealed unit requiring no lubrication or has an oil level plug. If the right-angle gear box has a level plug, fill with SAE-80 transmission oil. Check the oil level occasionally to see that the gear case is filled up to the level plug. See Illust. 16.



# LUBRICATION

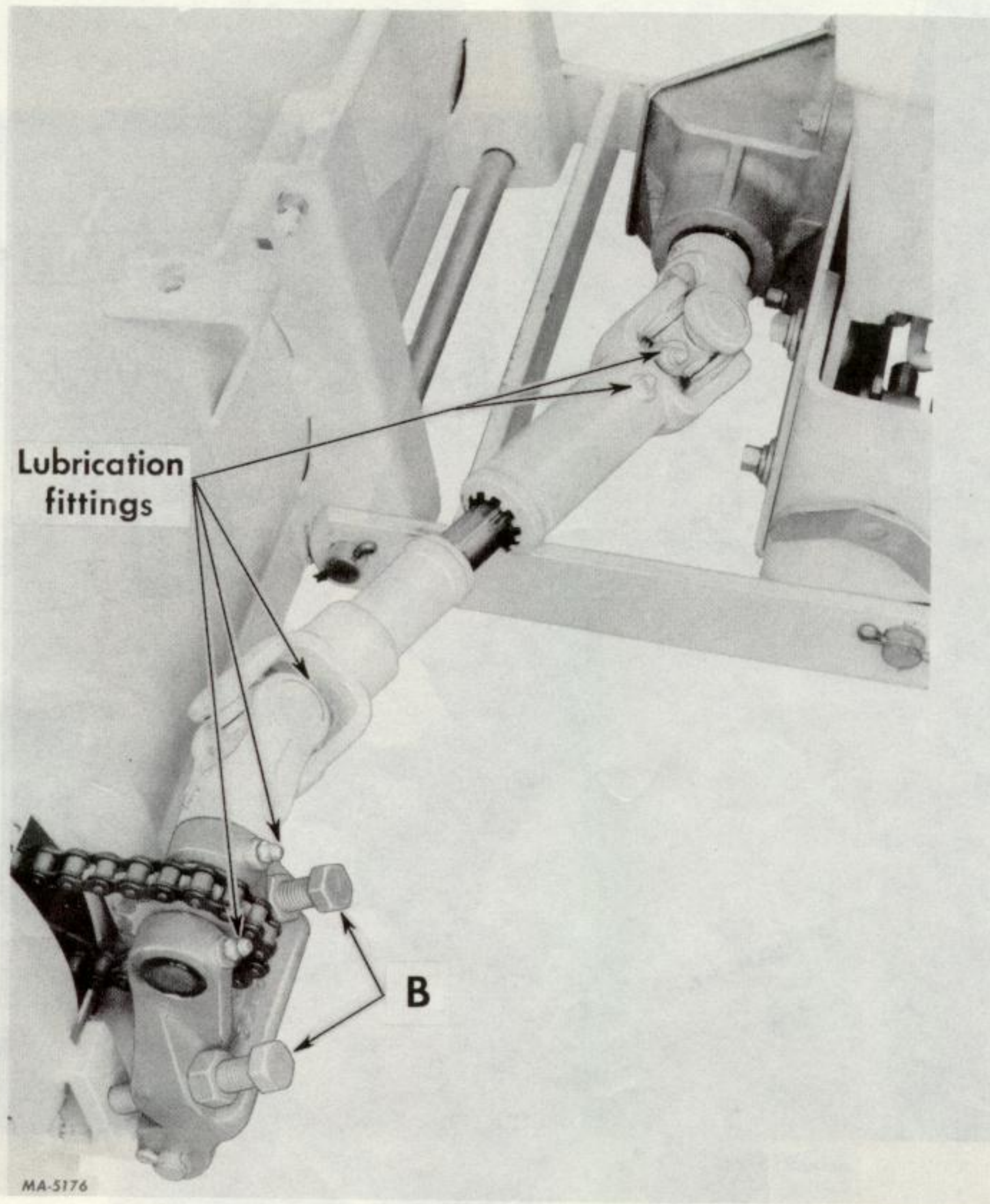

Illust. 16

The right-angle gear box is either a sealed unit requiring no lubrication or has an oil level plug. If the right-angle gear box has a level plug, fill with SAE-80 transmission oil. Check the oil level occasionally to see that the gear case is filled up to the level plug. See Illust. 16.

Each time the snow thrower is used, lubricate the universal drive assembly and the transfer shaft, using IH 251H EP grease or equivalent #2 multi-purpose lithium grease.

The rotor and idler bearings are sealed and do not require lubrication.



# MEMORANDUM

## Accidents can be prevented with your help

No accident-prevention program can be successful without the wholehearted co-operation of the person who is directly responsible for the operation of equipment.

To read accident reports from all over the country is to be convinced that a large number of accidents can be prevented only by the operator anticipating the result before the accident is caused and doing something about it. No power-driven equipment, whether it be transportation or processing, whether it be on the highway, in the harvest field or in the

industrial plant, can be safer than the man who is at the controls. If accidents are to be prevented—and they can be prevented—it will be done by the operators who accept a full measure of their responsibility.

It is true that the designer, the manufacturer, the safety engineer can help; and they will help, but their combined efforts can be wiped out by a single careless act of the operator.

It is said that "the best kind of a safety device is a careful operator." We ask you to be that kind of an operator.



# MEMORANDUM



Illustr. 16

The right-angle gear box is either a sealed unit requiring no lubrication or has an oil level plug. If the right-angle gear box has a level plug, fill with SAE-80 transmission oil. Check the oil level occasionally to see that the gear case is filled up to the level plug. See Illustr. 16.

Each time the snow thrower is used, lubricate the universal drive assembly and the transfer shaft, using IH 251H EP grease or equivalent #2 multi-purpose lithium grease.

The rotor and idler bearings are sealed and do not require lubrication.





# Accidents can be prevented with your help

No accident-prevention program can be successful without the wholehearted co-operation of the person who is directly responsible for the operation of equipment.

To read accident reports from all over the country is to be convinced that a large number of accidents can be prevented only by the operator anticipating the result before the accident is caused and doing something about it. No power-driven equipment, whether it be transportation or processing, whether it be on the highway, in the harvest field or in the

industrial plant, can be safer than the man who is at the controls. If accidents are to be prevented—and they can be prevented—it will be done by the operators who accept a full measure of their responsibility.

It is true that the designer, the manufacturer, the safety engineer can help; and they will help, but their combined efforts can be wiped out by a single careless act of the operator.

It is said that "*the best kind of a safety device is a careful operator.*" We ask you to be that kind of an operator.



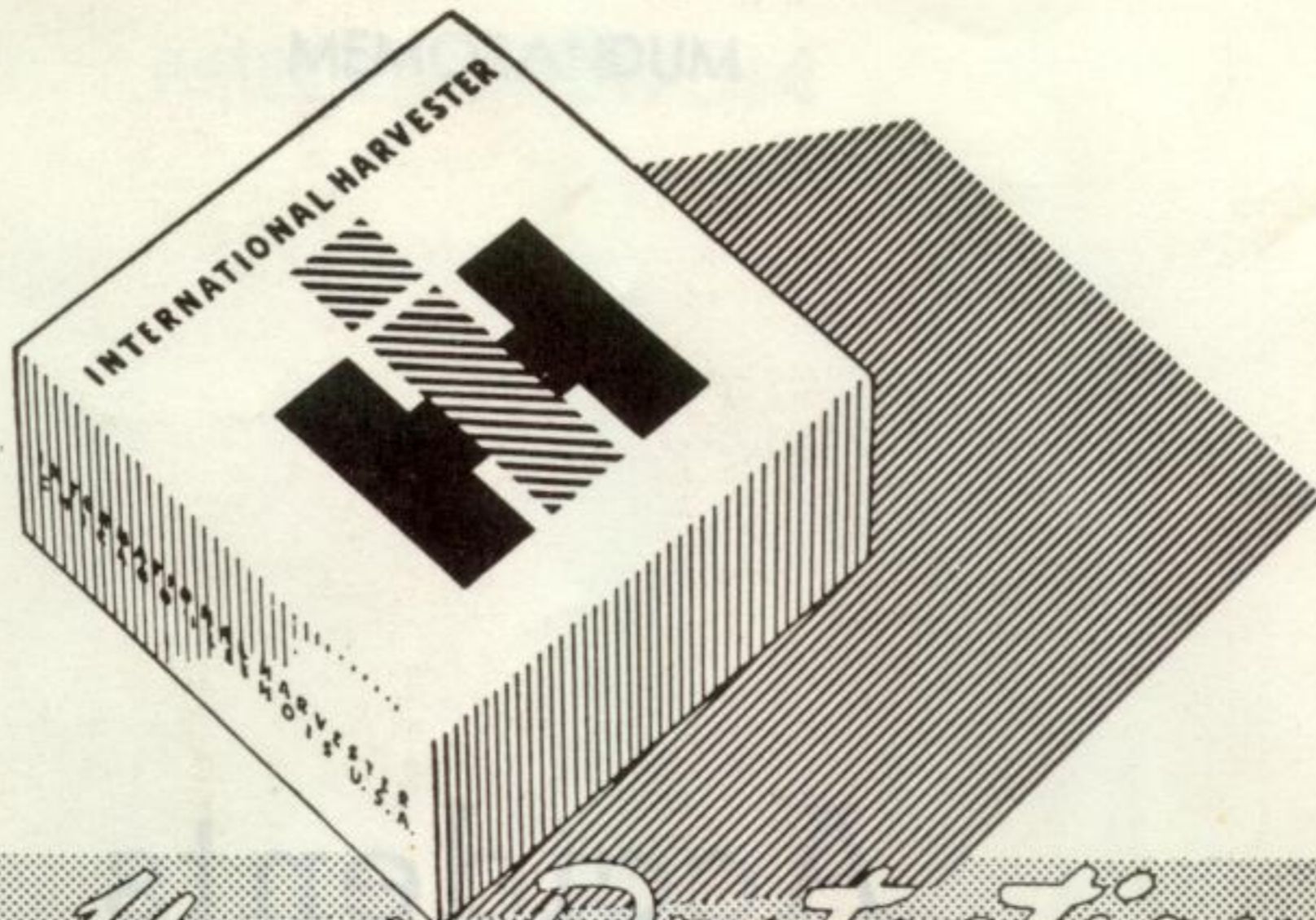

*For Your Protection*

## Use IH Parts

### TO THE OWNER—

*You have just purchased one of the finest pieces of equipment available today. You can look forward to years of good service because International Harvester machines are designed better and built better to last longer.*

*When you need to purchase replacement parts or have your equipment serviced, we will be here, ready to serve you.*

*We stock genuine IH parts—the parts that are designed for your equipment, not just made for it.*

*We also offer you IH Blue Ribbon Service—the service that puts your equipment back to work in minimum time at an economical cost. We are here to serve you—call on us in the future.*

*Sincerely,*

---

*Your IH dealer*

INTERNATIONAL HARVESTER COMPANY • 401 NORTH MICHIGAN AVENUE • CHICAGO, ILLINOIS 60611, U.S.A.

1 083 621 R1. 7-71

PRINTED IN UNITED STATES OF AMERICA